

Sears

TELE-GAMES®
ELECTRONIC GAMES

SUPER VIDEO ARCADE™

OWNER'S MANUAL

Illustrations: © Mattel, Inc. 1978. PRINTED IN HONG KONG. All Rights Reserved.

SEARS, ROEBUCK AND CO., Chicago, IL. 60684

3618-0920-G1

OPEN THE CARTON AND YOU WILL FIND THESE PARTS:

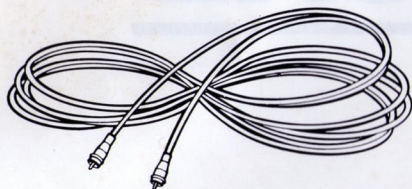
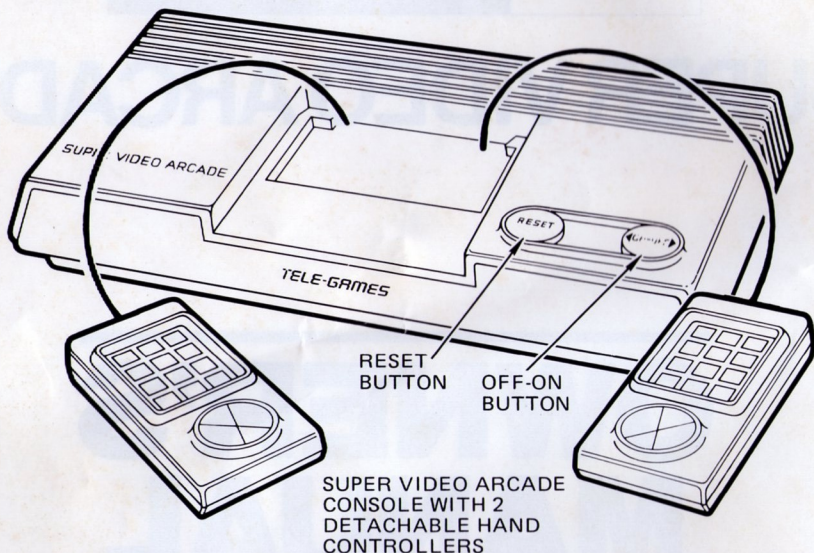

SWITCH BOX CABLE,
5 FEET LONG

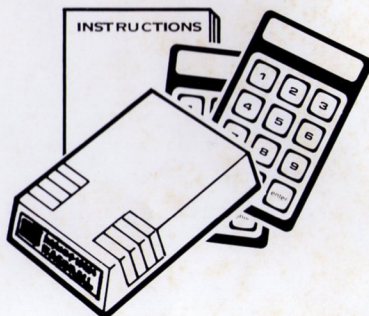
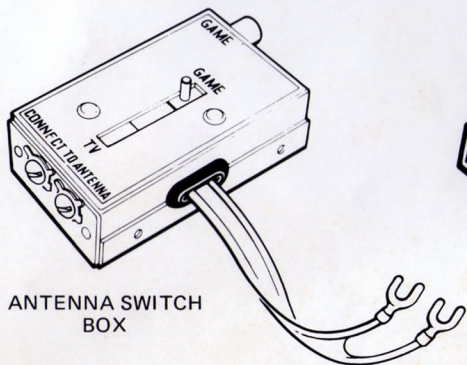

GAME
CARTRIDGE WITH
INSTRUCTIONS AND
2 CONTROLLER
OVERLAYS

Sears TELE-GAMES® SUPER VIDEO ARCADE.™

Model No. 497.75022 Serial No. _____

Both the model number and serial number are located on the bottom of the Super Video Arcade. Record and retain these numbers for future reference.

HOW TO CONNECT THE ANTENNA SWITCH BOX

The Antenna Switch Box enables you to use your television set for either regular television programming or with your game. Once the Antenna Switch Box is installed, a flick of the switch allows you to make your choice.

CONNECTING THE SWITCH BOX IS EASY. JUST FOLLOW THESE SIMPLE STEPS:

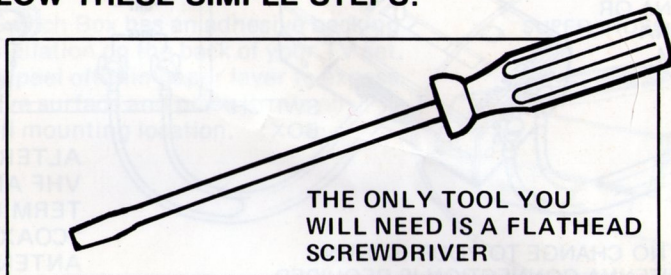

Disconnect the VHF antenna wire (if there is one) from your television set and connect it to the Antenna Switch Box (See page 3).

Connect the twin lead wire from the Switch Box to the VHF screw terminals of your television set (See page 3).

IMPORTANT! FEDERAL COMMUNICATIONS COMMISSION REGULATIONS REQUIRE:

- Never attach loose wires to your antenna terminals when you are using the Super Video Arcade.™
- The Antenna Switch Box comes with its own twin lead wire. Never substitute a longer twin lead wire from the Switch Box to your television set.
- Do not attach the twin lead wire from the Switch Box to any television antenna or cable-TV outlet.
- If you disregard any of the above rules, you may cause interference to nearby television sets.

NOTICE TO PROJECTION TV OWNERS Operating the Super Video Arcade for extended periods of time on a projection TV system, may cause the stationary game objects to become permanently imprinted on the projection TV picture tube(s). This is especially true when brightness and contrast controls are set extremely high for game viewing. Observing the following procedures will greatly minimize the chances of a game

image being retained on the screen.

1. Always use lowest possible brightness and contrast control settings during game operation.
2. Games containing stationary white or light colored objects should not be played for extended periods of time.
3. Follow your projection TV owners manual for proper viewing conditions for TV games as well as regular TV programming.

WHERE FLAT "TWIN LEAD" TYPE OF ANTENNA WIRE IS USED

CONNECT SWITCH BOX AS SHOWN.

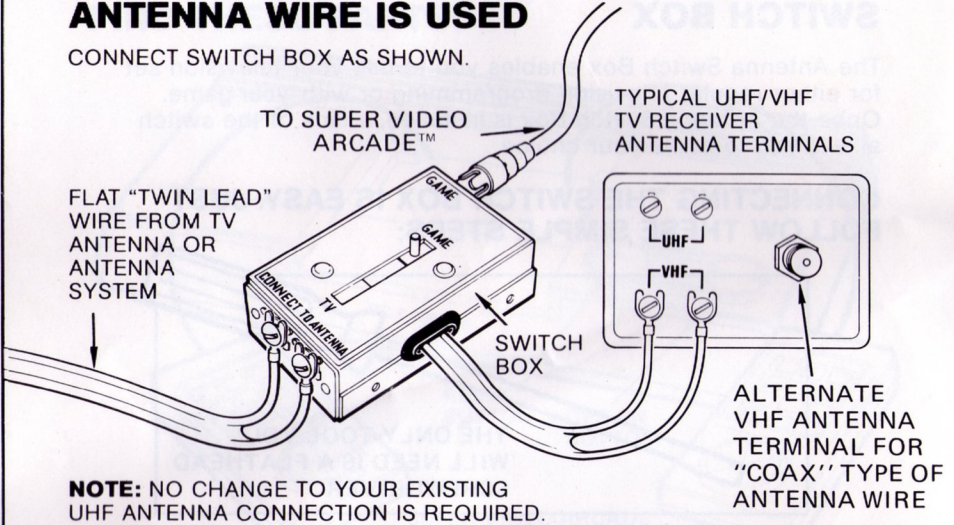

FOR TV INSTALLATIONS WHERE ROUND "COAX" TYPE OF ANTENNA WIRE IS USED

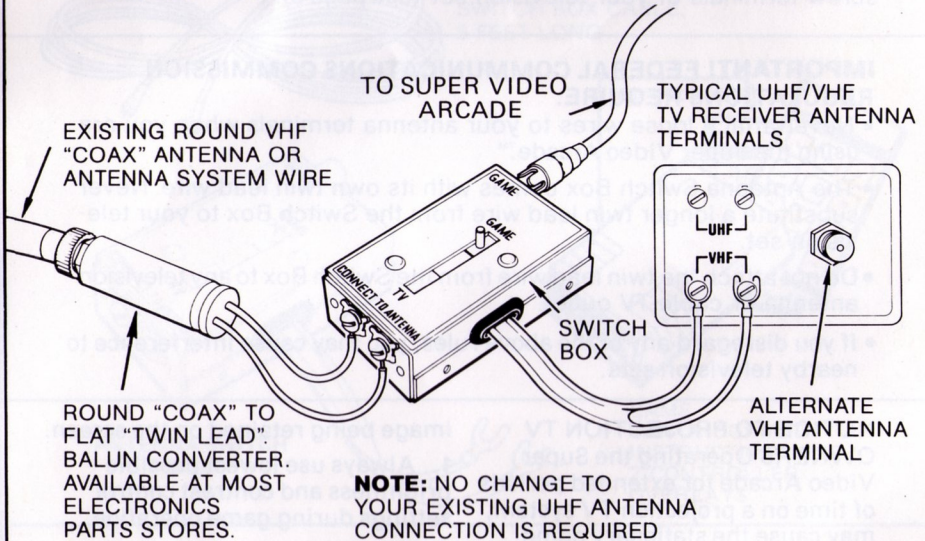

NOTE: FOLLOW THE DIRECTIONS IN YOUR TV OWNERS MANUAL OR ON THE BACK OF YOUR SET FOR CHOOSING BETWEEN THE ALTERNATE "COAX" VHF TERMINAL AND THE FLAT "TWIN LEAD" VHF SCREW TERMINALS. YOU MUST SELECT THE FLAT "TWIN LEAD" VHF SCREW TERMINALS WHEN USING THE SUPER VIDEO ARCADE SWITCH BOX.

SET UP YOUR SUPER VIDEO ARCADE™

1

Connect the Switch Box cable to the Switch Box by plugging into socket marked GAME CORD. Plug other end of cable into the right hand rear socket of the Super Video Arcade. It makes no difference which end goes into which socket.

Your Switch Box has an adhesive backing for installation on the back of your TV set. Simply peel off thin paper layer to expose adhesive surface and place firmly on desired mounting location.

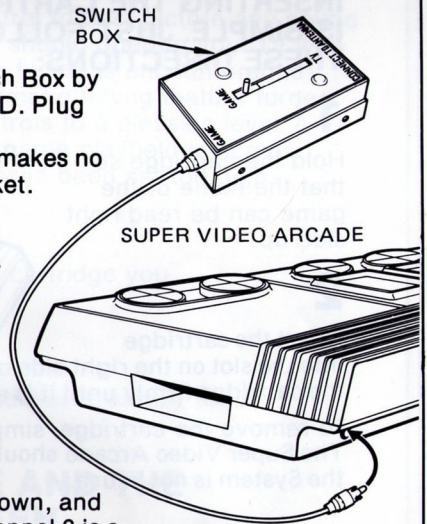

2

Turn the Super Video Arcade over, face down, and see switch labeled "CH 3 — CH 4." If channel 3 is a normal television station channel or cable channel in your area and channel 4 is not, then move the switch to channel 4.

If channel 4 is a normal television station channel or cable channel in your area and channel 3 is not, move the switch to channel 3.

If both channels 3 and 4 are normal television station channels or cable channels in your area, move the switch to the channel with the weaker reception. (If you receive channel 3 better than channel 4, move the switch to channel 4 and vice versa.)

3

Plug the wall plug of the Super Video Arcade into a 120 volt wall outlet. The Super Video Arcade plug will not fit a 220 volt outlet.

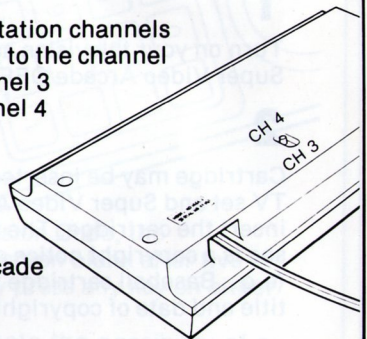

4

Set the Antenna Switch Box at GAME.

5

Turn on your television set.

6

Turn your television set to either channel 3 or 4, depending on where you set the Super Video Arcade switch in Step 2. If switch is set on CH 3, turn TV set to channel 3. If switch is set on CH 4, turn TV set to channel 4.

HOW TO INSERT GAME CARTRIDGES

INSERTING THE CARTRIDGE IS SIMPLE. JUST FOLLOW THESE DIRECTIONS:

1

Hold the cartridge so that the name of the game can be read right side up.

2

Insert the cartridge into the slot on the right side of the Super Video Arcade™. Insert the cartridge firmly until it is engaged, but do not force it.

To remove the cartridge, simply pull it straight out of the slot. The Super Video Arcade should be turned to OFF when the System is not in use.

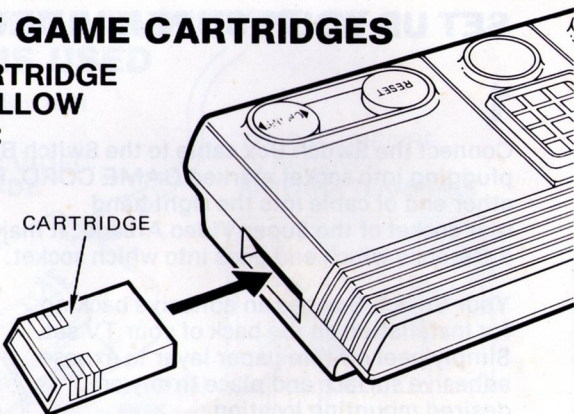

HOW TO USE THE SUPER VIDEO ARCADE™

1

Turn on your television set and slide the Super Video Arcade OFF/ON switch to ON.

2

Cartridge may be inserted before turning on TV set and Super Video Arcade. If not, insert the cartridge. The first thing you will see is a copyright notice and game title, (e.g., Baseball cartridge will show game title and date of copyright.)

RESET
BUTTON

SUPER VIDEO
ARCADE OFF/ON
BUTTON

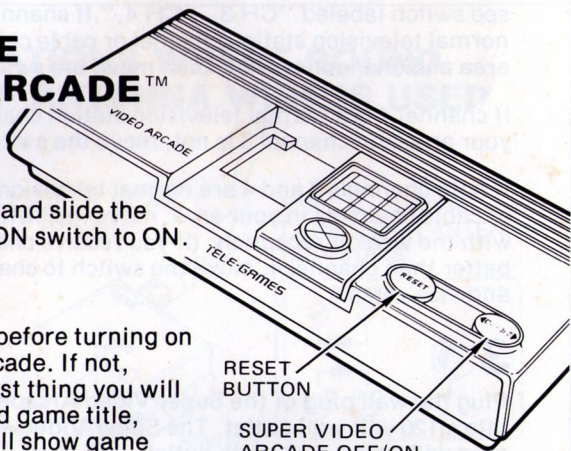

NOTE: If no playfield appears on your television screen or if the screen image does not make sense, check to be sure that the cartridge is inserted properly, that the power is on, and that all connections are properly made. If everything is correct merely push the RESET button on top of Super Video Arcade. This will remedy the problem. What has happened is that the game program has been picked up at the wrong point. Pushing the RESET button gets the computer started at the beginning.

3

Adjust fine tuning control on channel 3 or channel 4 of television. If it is not normally used, it is likely to be badly out of adjustment.

4

Adjust the television VHF fine tuning control to best picture and sound. If your set has automatic fine tuning you should operate your TV with automatic fine tune on. If difficulty in fine tuning is encountered, try tuning in the game channel with the automatic tuning feature turned off. Adjust volume, picture and color controls to a pleasing level. A gradual discoloring of white areas in the game playfield indicates that the brightness or contrast controls have been set too high.

5

Follow the instruction book for individual cartridge you are using.

6

If at any point in the game you wish to start over, simply press the RESET button.

THE INTERMISSION CODE AND THE AUTOMATIC BLANK SCREEN

If for any reason you wish to interrupt your game, use the Intermission Code on your Hand Controller. Merely depress keys 1 and 9 *simultaneously* on either one of the Hand Controllers. This will cause the television screen to go blank and will freeze the game at the point you left it. To resume the game, just push any key on either Hand Controller and the game will begin again where you left off.

DEPRESS KEYS 1 AND 9

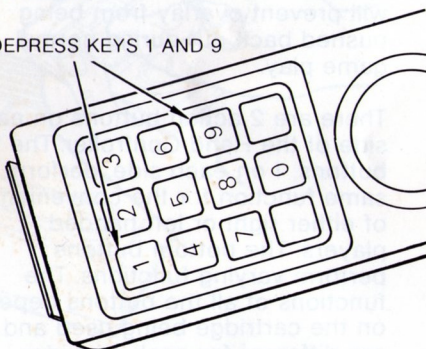

If you leave the game without using the Intermission Code, the Super Video Arcade will automatically turn the screen blank after five minutes. To turn the screen on again, you simply press any key on either Hand Controller.

The purpose of this unique feature is to eliminate the possibility of a permanent playfield image being imprinted on your television screen.

HOW TO RETURN YOUR TELEVISION SET TO REGULAR PROGRAMMING

1

Slide the POWER switch on the Super Video Arcade™ to OFF.

2

Slide the switch on the Antenna Switch Box from GAME to TV.

THE HAND CONTROLLERS

The Super Video Arcade™ contains two Hand Controllers which are attached with cables.

Since the Hand Controllers are crucial to any game you play, hold the Hand Controller in your hand before you begin play, just to get the feel of it.

You will notice that there are 12 keys on the keypad. These are used for feeding data into the computer.

With each cartridge, there are 2 overlays which fit over the keypads of the 2 Hand Controllers. These overlays are keyed to the particular game being played and determine how the keys on the keypad relate to the cartridge. Slip the overlay under the keypad frame as shown. The lip at the top of the controller will prevent overlay from being pushed back out during normal game play.

There are 2 action buttons on each side of the Hand Controller. The top buttons, 1 on each side, perform the same function for the convenience of either right or left handed players. The bottom buttons perform varying functions. The functions of all the buttons depend on the cartridge being used and are different for each cartridge overlay.

The disc at the base of the Hand Controller is a directional control for those cartridges in which direction is a factor. *There are 16 directions on the disc. Direction of disc corresponds to direction on television screen. UP on the disc (toward the keypad) is UP on the screen, etc. For further instructions refer to your cartridge instructions.*

To operate the directional disc, press your finger on the outer edge and slide your finger around the edge to change direction of object you are moving. You have the ability to move

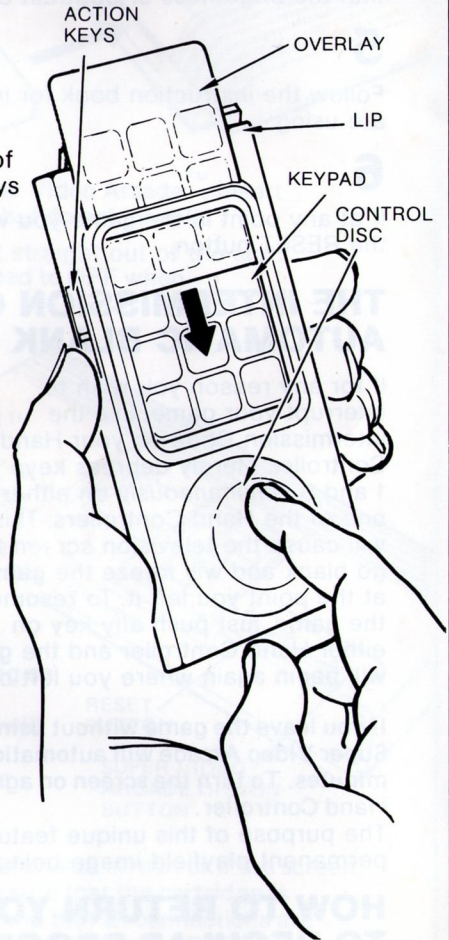

the object in any direction you wish. To stop motion, simply stop pressing disc. You must be pressing on the disc in some direction for motion to take place.

The keypad buttons and directional disc cannot be operated simultaneously. However, the action buttons and directional disc can be. See cartridge instructions.

When returning the Hand Controller to the Super Video Arcade,[™] coil the cable in the cradle.

HOW TO TAKE CARE OF YOUR SUPER VIDEO ARCADE[™]

The TELE-GAME[®] Super Video Arcade from Sears will bring you many years of fun and excitement if you follow a few simple rules to keep it in good condition. Read the following points carefully. They will help you get the maximum use from your Super Video Arcade.

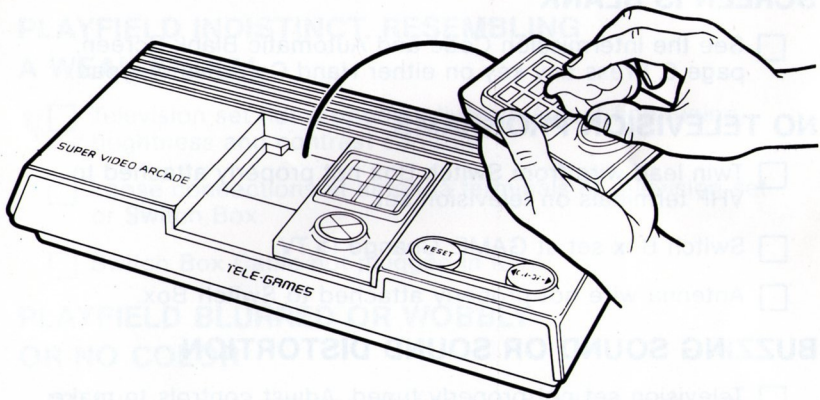

Do not force the cartridge into the component slot.

Cartridges from Sears are designed to inhibit hand contact with their electronic circuitry. However, care should be taken not to get the fingers into the open end of the cartridge. Static electricity, such as the kind you get from a rug, could damage the sensitive electronic components in the cartridge.

Turn the Super Video Arcade OFF when not in use.

If the Super Video Arcade is not to be used for a length of time the Switch Box Cable may be unplugged and stored behind TV while the AC power cord may be pushed inside of Super Video Arcade.

Handle the Super Video Arcade carefully. Do not drop the cartridges, components or Hand Controllers.

Do not lift the Super Video Arcade or the Hand Controllers by the wires, as serious damage can result.

Avoid exposing the cartridges, Super Video Arcade™ or Hand Controllers to excessive heat.

Do not set large objects which would block ventilation openings on top of Super Video Arcade housing.

Do not spill liquids onto the cartridges, Super Video Arcade or Hand Controllers.

Clean the exterior of your Super Video Arcade with a soft, *slightly* dampened cloth. **BUT ONLY AFTER YOU HAVE TURNED THE POWER "OFF" AND DISCONNECTED THE POWER CORD FROM THE 120 VOLT WALL OUTLET.**

NOTE: It is normal for the top of Super Video Arcade to become warm during operation. The lower left corner of the Super Video Arcade will be slightly warm even when the Super Video Arcade OFF/ON switch is in the OFF position.

TROUBLESHOOTING CHECKLIST

SCREEN IS BLANK

- See the Intermission Code and Automatic Blank Screen, page 6. Press any key on either Hand Controller keypad.

NO TELEVISION PROGRAMS

- Twin lead wire from Switch Box not properly attached to VHF terminals on television set.
- Switch Box set at GAME. Change to TV.
- Antenna wire not properly attached to Switch Box.

BUZZING SOUND OR SOUND DISTORTION

- Television set not properly tuned. Adjust controls to make sound and picture clear.
- Broadcast interference on Channel 3, 4 or cable TV from an especially strong television station in your area. Disconnect the TV-VHF antenna wires from the Switch Box and continue playing, but you will have to reconnect again for TV viewing.

NO GAME SOUND EFFECTS

- Volume control on television set turned down. Turn it up.
- TV not fine tuned properly.

NO PLAYFIELD IMAGE OR WHITE-GREY SCREEN

- Cartridge not properly inserted in slot.

- Check all connections; make sure power plug is plugged into outlet and that outlet has not been turned off by wall switch.
- Make sure you are tuned to correct channel, either Channel 3 or 4.
- Antenna Switch Box set at TV, change to GAME.
- Cable not properly plugged into Switch Box.
- Super Video Arcade™ power switch not turned on.
- Twin lead wire from Switch Box not properly attached to VHF terminals on television set.

EITHER SIDE OF PLAYFIELD NOT VISIBLE ON SCREEN

- Adjust the horizontal hold control on your television set.

PLAYFIELD INDISTINCT, RESEMBLING A WEAK SIGNAL

- Television set not properly adjusted. Adjust fine tuning, brightness and contrast controls.
- Loose connections at antenna terminals of television set or Switch Box.
- Switch Box Cable not plugged in fully.

PLAYFIELD BLURRED OR WOBBLY OR NO COLOR

- Television set not properly fine tuned. Adjust television fine tuning, color or tint controls.
- Broadcasting on Channel 3, 4 or cable TV by an especially strong television station in your area. Disconnect TV - VHF antenna wires from the Switch Box. Reconnect to watch regular TV.



NOTE: If Super Video Arcade malfunctions after all troubleshooting steps have been taken, disconnect and determine if television set is functioning properly. If so, consult your Super Video Arcade Full Warranty for repair information.

HOW TO ORDER REPLACEMENT PARTS

MODEL NO. 497.75022

All parts listed herein may be ordered directly from any SEARS, ROEBUCK AND CO. retail or catalog store.

WHEN ORDERING REPAIR PARTS, ALWAYS GIVE THE FOLLOWING INFORMATION:

1. Part Number
2. Model Number
3. Name of Item

If the parts are not stocked locally, your order will be electronically transmitted to a Sears Repair Parts Distribution Center for expedited handling.

PART NO.	PART NAME
2609-9599	Switch Box Cable
75475	Switch Box
75421	Controller

EXTRA SWITCH BOXES

By attaching an Antenna Switch Box to each television set in your home, you can easily move your SUPER VIDEO ARCADE™ from room to room. Extra Antenna Switch boxes (part number 49-75475) are available through Sears, Roebuck and Co.

FULL 90-DAY WARRANTY ON SUPER VIDEO ARCADE

For 90 days from date of purchase, Sears will repair this Super Video Arcade™ Tele-Game, free of charge, if defective in material or workmanship.

Warranty service is available by simply returning the Super Video Arcade Tele-Game to the nearest Sears store throughout the United States.

This warranty gives you specific legal rights, and you may also have other rights which vary from state to state.

SEARS, ROEBUCK AND CO., BSC 41-3, Sears Tower, Chicago, IL 60684

"TOLL-FREE TELEGAMES® HOTLINE"

Please read the Owner's Manual carefully before using the product. If a malfunction occurs, please refer to the trouble-shooting checklist in the Owner's Manual. If you cannot correct the malfunction after consulting the trouble-shooting checklist, call the following toll-free number for assistance: (800) 421-5059. Alaska, California and Hawaii residents call direct or collect: (213) 978-6856.